

400 w 

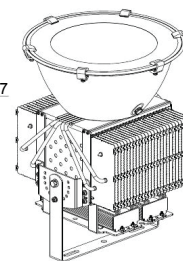

HIGH BAY

Yüksek koy

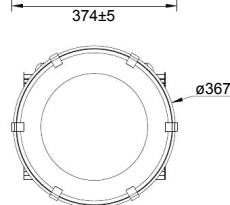
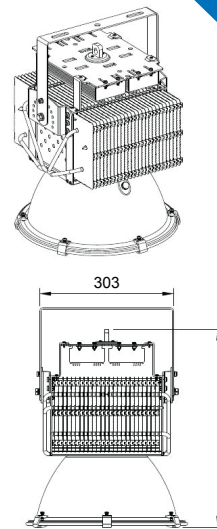
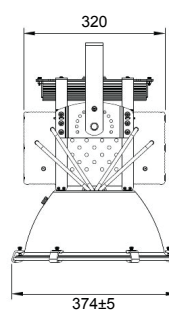
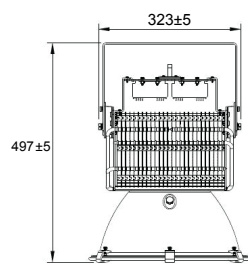
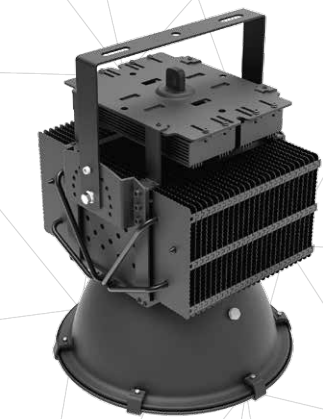

Product Information

Ürün Bilgisi

Product Name Ürün Adı	Part Number Parti/Parça Numarası	Materials malzemeler	Mounting montaj	Power Güç	Color Rendering Index(CRI) Renksel geriverim
High Bay Yüksek koy	NSL-HB400-XW-TY2H-6000K NSL-HB400-XW-TY2H-4000K NSL-HB400-XW-TY2H-3000K	Aluminum+PC Alüminyum + Bilgisayar	- Post side mounted column/wall by using special support - Özel destek kullanarak yan monte sütun / duvar	400 Watt 400 Vat	80%
beam angle Hüzme/Demet Açısı	Working temperature Çalışma Isısı	IP rating IP Koruma Derecesi	Lifespan Yaşam Süresi	Warrenty Garanti Süresi	Lumen/Watt Lümen/Vat
100 °	-40 +70°	IP65	50,000 Hrs 50,000 Saat	Long Period	98.39
Input Voltage Giriş Gerilimi	Power Factor Correction (PFC) güç Faktörü düzeltmesi	LEDs	Flux Akış	color temperature(CCT) renk sıcaklığı	Dimensions Boyutlar
100-240V AC 50-63Hz	>.90	SMD OR COB	38569 Lum	6000/4000/3000	L 260 W374±5 H497±5

Photometric

Fotometrik

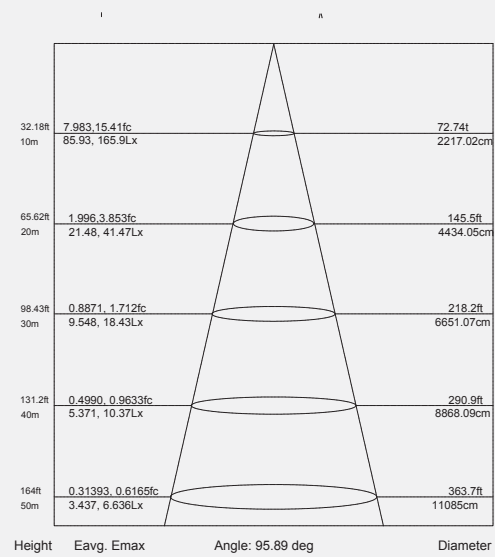
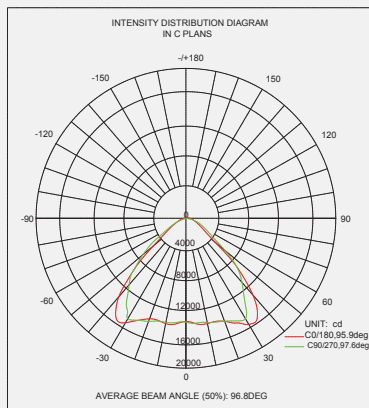
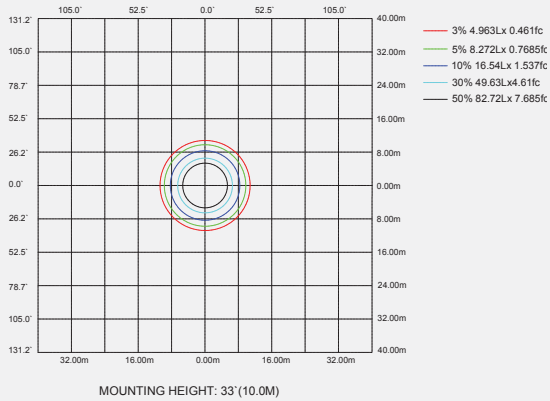

Order Code Sipariş Kodu	Color Temperature Renk sıcaklığı	Power Güç	Weight(Kg) Ağırlık(kg)
NSL-HB400-XW-TY2H-6000K	6000k	400	10.20kg
NSL-HB400-XW-TY2H-4000K	4000K	400	10.20kg
NSL-HB400-XW-TY2H-3000K	3000K	400	10.20kg